



Optimization Technique for Voltage Sag with Integration of Photovoltaic Energy Distributed Generation

Papon Ngamprasert¹ and Nattachote Rugthaicharoencheep^{1,*}

ARTICLE INFO

Article history:

Received: 02 July 2021

Revised: 11 January 2022

Accepted: 10 March 2022

Keywords:

Voltage sag

Distributed generation

Photovoltaic

Distribution system palmer

ABSTRACT

This paper shows optimization technique for voltage sag with integration of photovoltaic energy distributed generation. Voltage sag optimization is a factor that affects power distribution systems. Power fluctuations and supply faults typically use a dynamic voltage stabilizer (DVR) under bus current limitations and voltage limits technical. The modeling solution is applicable to an IEEE 69-bus distribution system with a photovoltaic distributed generator with using a MATLAB program. Techniques to solve voltage sag in the power distribution system using Tabu Search (TS). Photovoltaic power distribution system problems use energy flow algorithms. The results show that photovoltaic power plants can increase the efficiency of reducing the voltage in the power distribution system.

1. INTRODUCTION

In the future, the part of distributed generator (DG) in power and distribution systems will increase. The future grid will efficiently and effectively link small and medium-sized electrical energy sources to customer needs. DG is used as backup power to increase reliability, reduce the use of electrical energy from the electrical grid, and reduce power losses in transmission lines [1].

size of DG has many definitions, and they are indicated in Table 1.

Nowadays, the most widely used DG today comes from renewable energy sources. Renewable energy power plant projects are often called “Clean Energy” [7]. The clean energy is indicated in Fig. 1.

Table 1. The definitions of DG size

Ref.	Definitions
[2]	The Department of Energy considers DG to have sizes ranging from less than 1 kW - 10 MW.
[3]	In New Zealand DG capacity is less than 5 MW.
[4]	Sizes between 25 kW - 25 MW are the DG definition of Gas Research Institute.
[5]	Sizes between a few kW - 50 MW are the DG definition of Electric Energy Research Institute (EPRI).
[6]	In Australia, DG is less than 30.

The production of electrical energy is an important part of the operation of the electrical system. Electrical energy production has many sources, and a variety of technologies. Typically, electrical energy is produced from coal power plants. DG is production of small electrical energy distributed to various locations. It is close to the load. The

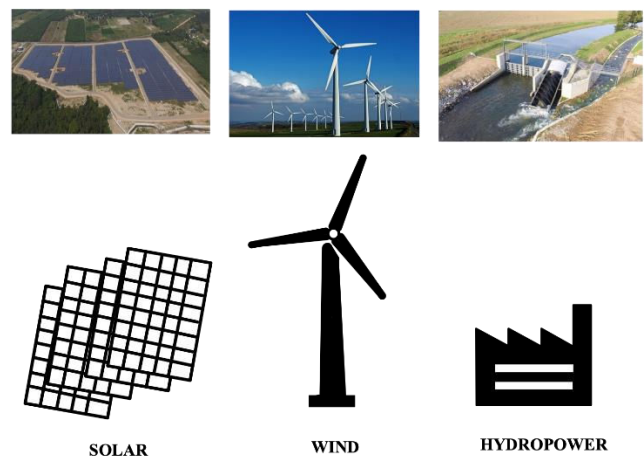

Fig. 1. The clean energy.

Fig. 1. shows the type of clean energy viz. solar energy, wind energy and hydropower. Distribution system and installation of many types of DGs are indicated in Fig. 2.

The energy flow of the distribution system is affected. The key variable is the emergence of DG in the system [8]. Positive effects of DG installation are as follows:

- Power loss of the system is reduced.

¹Department of Electrical Engineering, Faculty of Engineering, Rajamangala University of Technology Phra Nakhon, Bangkok, 10800, Thailand.

*Corresponding author: Nattachote Rugthaicharoencheep; Phone: +66-61-353-6426; E-mail: nattachote.r@rmutp.ac.th.

- Utility systems reliability is enhanced.
- Power quality is enhanced.

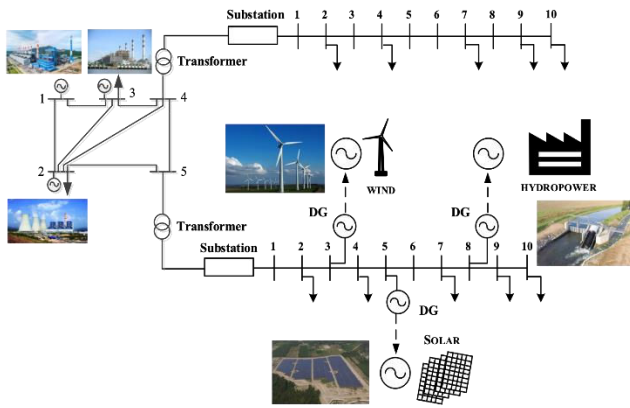

Fig. 2. Distribution system and installation of many types of DGs.

Improving voltage at the death end distribution system with DG installation is indicated in Fig. 3.

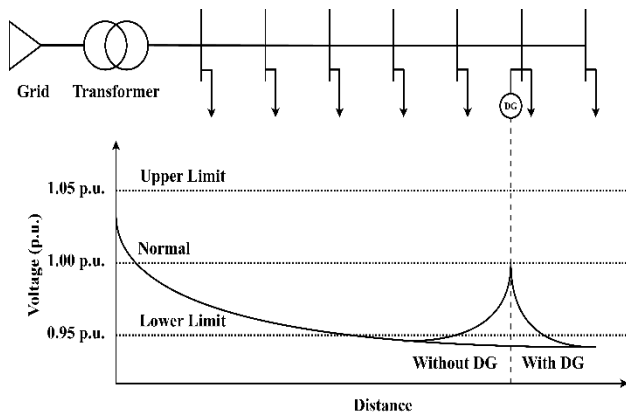

Fig. 3. Improving voltage at the death end distribution system with DG installation.

Distributed generation technology with solar energy solutions based on voltage sag problem.

The voltage sag refers to the magnitude and duration. Each standard varies, so IEC standards and IEEE standards are based on definitions.

- IEC 61000 - 4 - 30 (2003) standard states that voltage dip is a phenomenon in which the voltage suddenly drops and returns to normal within a period of 0.5 cycles to approximately 2–3 seconds [9].

- IEEE Standard 1159 - 1995 states that within 0.5 cycles to 1 min. period, RMS voltage drops between 0.1 and 0.9 per unit, which is called voltage sag [10]. A characteristic of voltage sag based on IEEE Std. 1159-1995 is indicated in Fig. 5. This paper shows an enhancement of the photovoltaic performance in synergy with voltage sag on distribution systems.

Voltage sag optimization is a factor that affects power distribution systems. Power fluctuations and supply faults typically use a dynamic voltage stabilizer (DVR) under bus

current limitations and voltage limits technical. The modeling solution is applicable to an IEEE 69-bus distribution system with a photovoltaic distributed generator using a MATLAB program. Tabu Search (TS) Technique is used for solving the problem of voltage sag in the power distribution system. Photovoltaic power distribution system problems use energy flow algorithms.

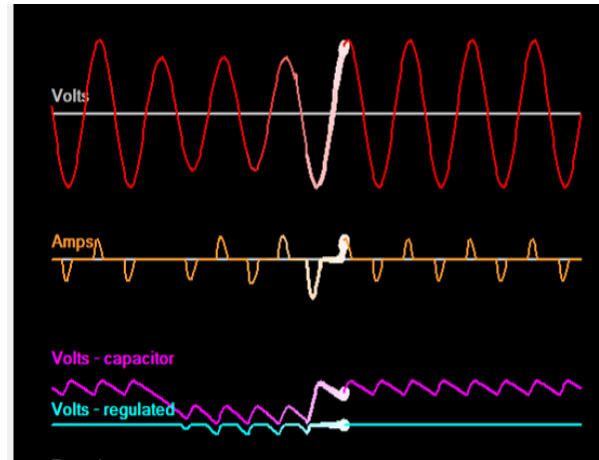

Fig. 4. Voltage sag.

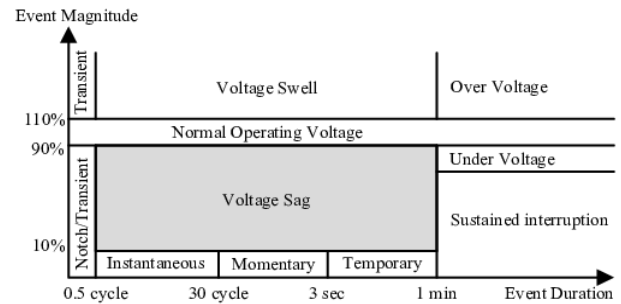

Fig. 5. A characteristic of voltage sag based on IEEE Std. 1159-1995.

2. VOLTAGE SAG

Voltage dip of 80% or voltage sag of 20% means the voltage has dropped from the specified value of 80 percent to the level of 20 percent of the specified value as indicated in Fig. 6.

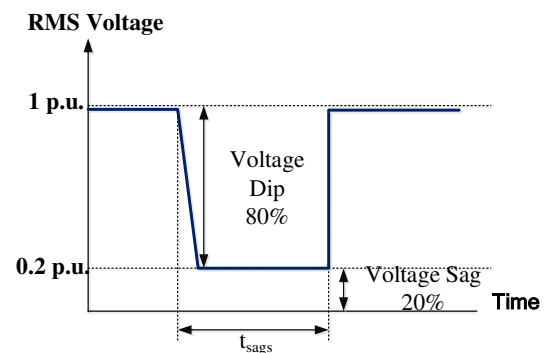

Fig. 6. Definition of voltage dip of 80% or voltage sag of 20%.

The comparison of standards between IEC 61000 - 4 - 30 (2003) and IEEE 1159-1995 is indicated in Table 2.

Table 2. The comparison of standards between IEC 61000 - 4 - 30 (2003) and IEEE 1159-1995

Variable	Standard	
	IEC 61000 – 4 – 30 (2003)	IEEE 1159 – 1995
Name	Voltage Dip	Voltage Sag
Scale)p.u.(0.0 - 0.9	0.1 – 0.9
Duration	½ cycle – 2 or 3 sec	½ cycle – 1 min

3. PHOTOVOLTAIC CELL

Photovoltaic (PV) cell is a device that converts solar energy into electrical energy using the photovoltaic effect [11]. PV is clean, green, and natural energy [12]. PV system is indicated in Fig. 7.

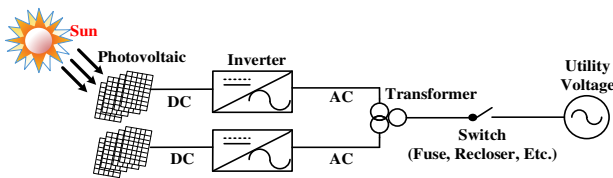

Fig. 7. PV system.

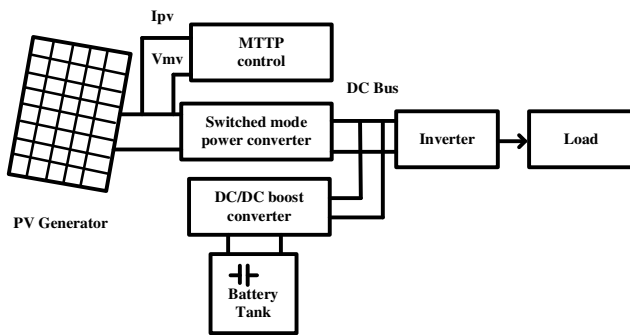

Fig. 8. DC equipment of the PV system.

In Fig.7 the PV system can be divided into two sections: viz direct current (DC) section and alternative current (AC) section. DC equipment of the PV system is indicated in Fig. 8.

Fig. 8. shows the DC equipment of the PV system viz PV generator, Maximum Power Point Tracking (MPPT), switched tank converter, DC to DC converter, and battery tank. The variability of electrical energy production of solar panels is light intensity [13].

In Fig. 9, the model of a photovoltaic system is relevant to grid system of the Provincial Electricity Authority (PEA.) of THAILAND. is indicated in Fig. 9.

According to the analysis of various parameters of solar cells, the solar cell must be replaced by an equivalent circuit. The model of a photovoltaic circuit in practice is indicated in Fig. 10. [14].

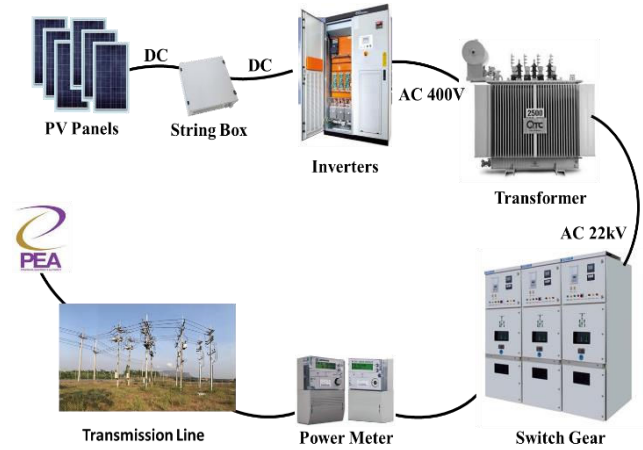

Fig. 9. The model of a photovoltaic system is relevant to grid system of the Provincial Electricity Authority (PEA.) of Thailand.

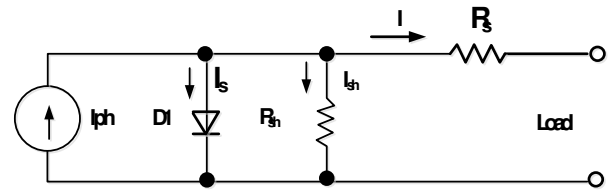

Fig. 10. The model of a photovoltaic circuit in practice.

Fig. 10. shows the model of a photovoltaic circuit in practice consists of a constant current source connected in parallel with diodes and a resistance in series due to the resistance of the silicon layer and the resistance of the front and rear metal terminals that results from connecting to an external connector. The electric current leakage leads to the resistance connected in parallel due to an incomplete P-N junction that can cause some short circuits, especially near the edge of the solar cell. Various values can be calculated in equation (1) [15].

$$I = I_{ph} - I_s \left[\exp \frac{q \cdot (V + I \cdot R_s)}{N \cdot K \cdot T} - 1 \right] - \frac{(V + I \cdot R_s)}{R_{sh}} \quad (1)$$

- where I is electric current of the solar panel (A)
- I_s is saturation leakage current during reverse bias of the diode (A)
- q is electron charge equal to 1.602×10^{-19} (C)
- N is ideal factor value
- K is Boltzman's constant and is equal to $1.3806504 \times 10^{-23}$ (J/Kelvin)
- T is temperature at the junction during cell operation ($^{\circ}$ K)
- V is voltage drop across the diode (V)
- R_s is cell series resistance (Ω)
- R_{sh} is cell parallel resistance (Ω)

4. FORMULATION

Voltage sag percentage can be calculated as shown in equation (2) [16-18].

$$Sag (\%) = \frac{V_{pre\ sag} - V_{sag}}{V_{pre\ sag}} \tag{2}$$

Voltage drop (VD) can be calculated as follow:

$$Maximum\ demand = \frac{Sum\ of\ kVA\ rating\ of\ distribution\ transformers}{Diversity\ factor} \tag{3}$$

$$\%VD = \frac{VD\ per\ km.\ kVA \times (total\ km.\ kVA)}{Diversity\ factor} \tag{4}$$

$$Demand\ factor = \frac{1.732 \times kV \times maximum\ demand}{Sum\ of\ kVA\ rating\ of\ distribution\ transformers} \tag{5}$$

$$\%VD = VD\ per\ km.\ kVA \times (total\ km.\ kVA) \times demand\ factor \tag{6}$$

Reactive power is calculated as shown in equation (7).

$$Q_G = P_G \tan(\cos^{-1}(pf_G)) \tag{7}$$

From equation 7, the DG power factor specified the use of variables, pf_G .

5. SOLUTION METHODOLOGY

In this paper, Tabu Search (TS) technique is used to solve voltage sag problem. TS is a reliable optimization technique for estimating a result. TS is based on solving problem procedure designed to cross boundaries of feasibility or local optimality. The neighborhood structure by moves is used in constructive and pattern processes, as indicated in Fig. 11.

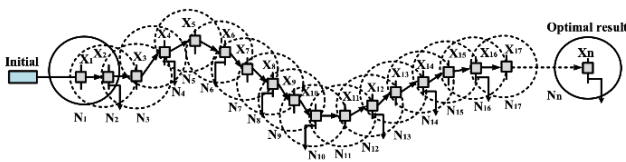

Fig. 11. The concept of Tabu.

TS is a thinking algorithm used to effectively solve a system problem. TS is known as a combination optimization problem made by a descent mechanism to move to a value lower than the target value. TS has the ability to avoid endemic narrow-band optimal answers and can continue to search for answers until the answer is closer to the best possible answer. Close answer (Neighborhood) is the process of finding the best answer nearby and select a new answer that is better than the current answer by evaluating the answer from those surrounding values. Then select the best answer to come to the next answer. Illustration of the main idea of Tabu search [19-20] is indicated in Fig. 12.

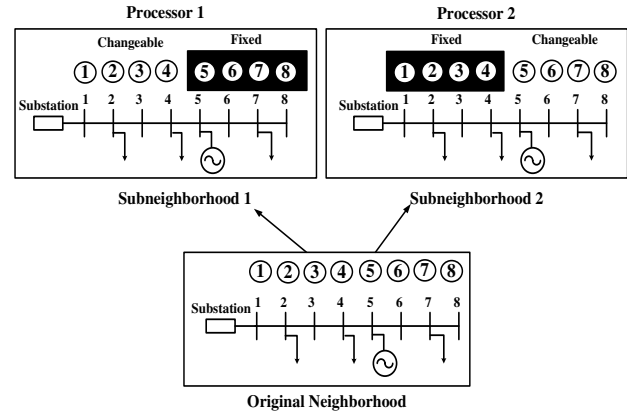

Fig. 12. Finding Tabu Direction.

Find the ON/OFF pattern of exciter and transfer switches by using the Tabu search [19-20]. Radial 10-bus DG is installed at 5-bus as indicated in Fig. 13.

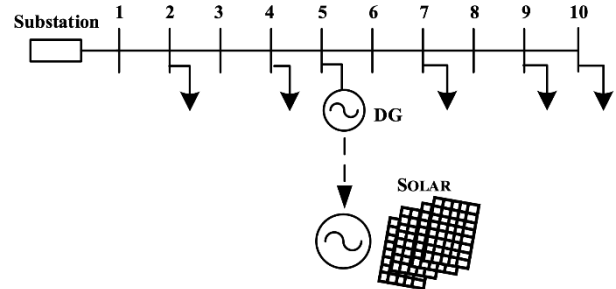

Fig. 13. Radial DG 10 bus installed at bus 5.

6. CASE STUDY

The system test uses an IEEE 69-bus distribution system as indicated in Fig. 14.

Fig. 14. shows that 100,000,000 VA is a base system, and 12,660 V is a base voltage. Load data and line data of IEEE 69-bus distribution system are indicated in Table AI and AII, respectively [21]. Sectionalizing switches are numbers from 1 to 68. Switches and tie switches are numbers from 69 to 73. 3,801,890 W and 2,694,100 Var are the total load of the system.

Case study is divided into 3 cases:

- Case 1: distribution system without PV.
- Case 2: distribution system with PV 5 units.
- Case 3: distribution system with PV 9 units.

Table 3. The area (zone) and size of PVs from Tabu search technique

Install at Bus	19	29	36	39	49	53	59	62	69
Size of PV (kW)	300	400	100	100	100	400	100	400	200

The area (zone) and size of PVs from Tabu search technique are indicated in Table 3.

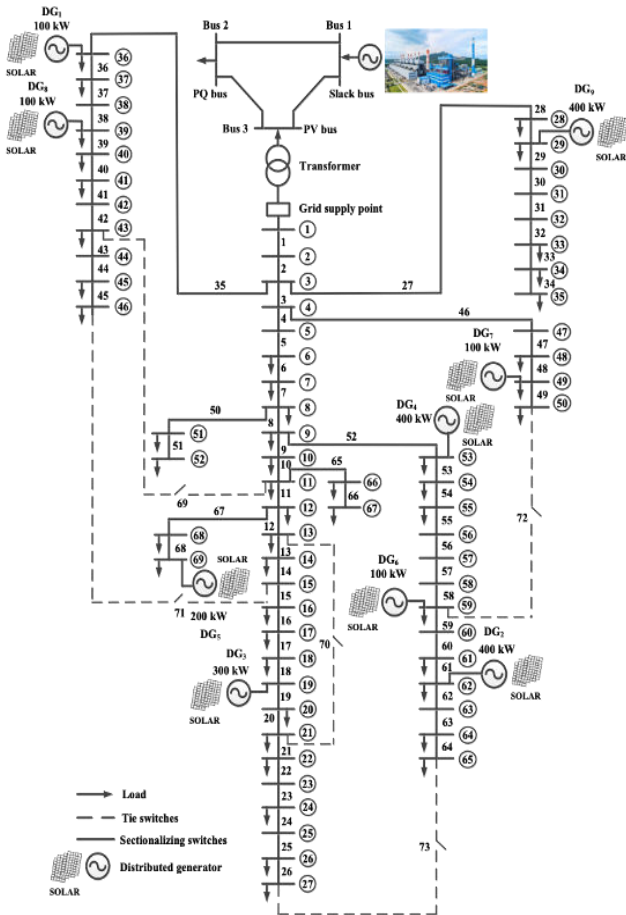

Fig. 14. IEEE distribution system 69 bus.

7. RESULTS

The voltage profile case 1: distribution system without PV is indicated in Fig. 15.

From Fig. 15 is the result of case 1: distribution system without PV. Bus 57-65 has a voltage value below standard (0.95-1.05 per unit). Bus 5 is the lowest voltage (0.909 per unit).

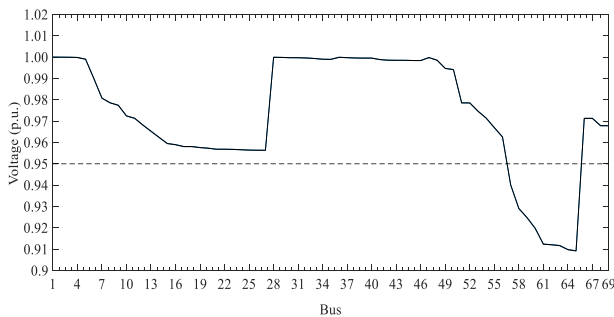

Fig. 15. The voltage profile case 1: distribution system without PV.

The voltage in case 2: distribution system with PV 5 units is indicated in Fig. 16.

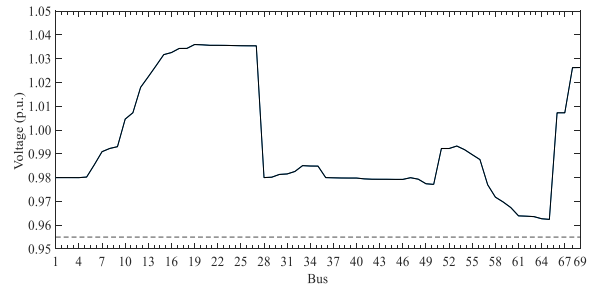

Fig. 16. The voltage profile case 2: distribution system with PV 5 units.

From Fig. 16 is the result of case 2: distribution system with PV 5 units. The voltage rating overall bus in test system slightly is higher than standard.

The voltage profile case 3: distribution system with PV 9 units is indicated in Fig. 17.

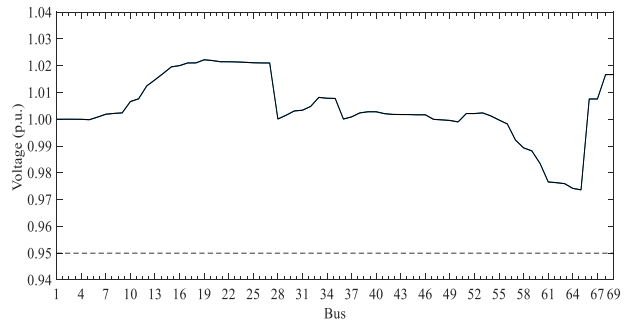

Fig. 17. The voltage profile case 3: distribution system with PV 9 units.

From Fig. 17 is the result of case 3: distribution system with PV 9 units. In this case voltage rating overall bus in test system is higher than standard.

8. CONCLUSION

This paper shows the solution of voltage sag by installing a photovoltaic DG with Tabu search technique on the distribution system. IEEE distribution system 69-bus is used for system testing. Case study is divided into 3 cases as follows: Case 1: without PV in distribution system, Case 2: distribution system with PV 5 units, Case 3: distribution system with PV 9 units. The results show voltage rating overall bus in test system within standard as follows: case 1: voltage at bus 57-65 below the standard, case 2 and case 3: when installing PV 5 and 9 units, respectively in distribution system. The intergrade connection photovoltaic power plant synergy distribution system can increase the efficiency of enhancing voltage in the system.

ACKNOWLEDGMENT

The authors would like to thank Rajamangala University of Technology Phra Nakhon, Thailand for generosity and support.

REFERENCES

[1] S. S. Niwas, “Distributed Generation in Power Systems: An Overview and Key Issues,” 24th Indian Engineering Congress, 2009.

[2] The US Department of Energy, Office of Distributed Energy, Resources, 2003, [Online]. Available: <http://www.eere.energy.gov/der/>

[3] T. Ackerman, G. Anderson, and L. Soder, “Distributed generation: a definition,” *Electric Power System Research*, vol. 57, pp. 195–204, 2001.

[4] Gas Research Institute, *Distributed Power Generation: A Strategy for a Competitive Energy Industry*, Gas Research Institute, Chicago, USA 1998.

[5] The Electric Power Research Institute, 2002, [Online]. Available: <http://www.epri.com/>

[6] B. M. Balmat, and A. M. Dicaprio, “Electricity market regulations and their impact on distributed generation,” in *Proc. Conf. on Electric Utility Deregulation and Restructuring and Power Technologies (DRPT 2000)*, pp. 608–613.

[7] A. Lomi, N. C. Hien, and N. Mithulananthan, “Application of distributed generation to enhance loadability of distribution system, a case study,” 2009 IEEE PES/IAS Conference on Sustainable Alternative Energy (SAE), 2009.

[8] P. Kritavorn, T. Lantharthong, and N. Rugthaicharoencheep, “The combined loss reduction approach to apply in distribution system with distribution generation,” *TENCON 2014 - 2014 IEEE Region 10 Conference*, 2014.

[9] IEC 61000-4-30. *Electromagnetic compatibility (EMC) – Part 4-30: Testing and measurement techniques – Power quality measurement methods*, 2003.

[10] IEEE Std 1159 – 1995. *IEEE Recommended Practice for Monitoring Electric Power Quality*, 1995.

[11] A. B Stanojevic, “Application of photovoltaic technology in the use of solar energy,” *Annals of Environmental Science and Toxicology*, 2021.

[12] P. Ngamprasert, P. Wannakarn, and N. Rugthaicharoencheep, “Enhance Power Loss in Distribution System Synergy Photovoltaic Power Plant,” *2020 International Conference on Power, Energy and Innovations (ICPEI)*, 2020.

[13] R. K. Varma, S. A. Rahman, V. Atodaria, S. Mohan, and T. Vanderheide, “Technique for Fast Detection of Short Circuit Current in PV Distributed Generator,” *IEEE Power and Energy Technology Systems Journal*, 2016.

[14] Anak Thongsungnoen, “Study and analysis of shading effect on solar module in photovoltaic system,” *Master of Engineering*, Rajamangala University of Technology Thanyaburi, 2014.

[15] S.R. Wenham, M.A. Green, M.E. Watt, *Applied Photovoltaics*, Centre for Photovoltaic Devices and Systems, UNSW.

[16] A. Kiswantono, E. Prasetyo, and A. Amirullah, “Comparative Performance of Mitigation Voltage Sag/Swell and Harmonics Using DVR-BES-PV System with MPPT-Fuzzy Mamdani/MPPT-Fuzzy Sugeno,” *International*

Journal of Intelligent Engineering and Systems, vol.12, no.2, pp.222-235, 2019.

[17] 1159-1995-IEEE Recommended Practice for Monitoring Electric Power Quality, New York, USA, 2009.

[18] A.O. Al-Mathnani, A. Mohamed, M. Alauddin, and M. Ali, “Photovoltaic Based Dynamic Voltage Restorer for Voltage Sag Mitigation”, In: *Proc. of 5th Student Conf. on Research and Development*, pp. 1-6, 2007.

[19] Mori, H. and Ogita, Y. “Parallel tabu search for capacitor placement in radial distribution systems,” *2000 IEEE Power Engineering Society Winter Meeting, Conference Proceedings*. 2002.

[20] Zimmerman, R. D. Murillo-Sánchez, C. E. and Gan, D. “A MATPOWER™ power system simulation package version 3.1b2,” *Power Systems Engineering Research (PSERC)*, 2006.

[21] N. Rugthaicharoencheep, and S. Sirisumrannukul, “Feeder reconfiguration for loss reduction in three phase distribution system under unbalanced loading conditions,” *45th International Universities Power Engineering Conference (UPEC2010)*, 2010.

APPENDIX

Table AI. Load Data of IEEE 69-Bus Distribution System

Bus Number	PL (kW)	QL (kVAr)	Bus Number	PL (kW)	QL (kVAr)
6	2.60	2.20	37	26.00	18.55
7	40.40	30.00	39	24.00	17.00
8	75.00	54.00	40	24.00	17.00
9	30.00	22.00	41	1.20	1.00
10	28.00	19.00	43	6.00	4.30
11	145.00	104.00	45	39.22	26.30
12	145.00	104.00	46	39.22	26.30
13	8.00	5.00	48	79.00	56.40
14	8.00	5.50	49	384.70	274.50
16	45.50	30.00	50	384.70	274.50
17	60.00	35.00	51	40.50	28.30
18	60.00	35.00	52	3.60	2.70
20	1.00	0.60	53	4.35	3.50
21	114.00	81.00	54	26.40	19.00
22	5.00	3.50	55	24.00	17.20
24	28.00	20.00	59	100.00	72.00
26	14.00	10.00	61	1,244.00	888.00
27	14.00	10.00	62	32.00	23.00
28	26.00	18.60	64	227.00	162.0
29	26.00	18.60	65	59.00	42.00
33	14.00	10.00	66	18.00	13.00
34	19.50	14.00	67	18.00	13.00
35	6.00	4.00	68	28.00	20.00
36	26.00	18.55	69	28.00	20.00

Table AII. Line Data of IEEE 69-bus Distribution System

Branch Number	From	To	R (Ω)	X (Ω)
1	1	2	0.0005	0.0012
2	2	3	0.0005	0.0012
3	3	4	0.0015	0.0036
4	4	5	0.0251	0.0294
5	5	6	0.3660	0.1864
6	6	7	0.3811	0.1941
7	7	8	0.0922	0.0470
8	8	9	0.0493	0.0251
9	9	10	0.8190	0.2707
10	10	11	0.1872	0.0619
11	11	12	0.7114	0.2351
12	12	13	1.0300	0.3400
13	13	14	1.0440	0.3450
14	14	15	1.0580	0.3496
15	15	16	0.1966	0.0650
16	16	17	0.3744	0.1238
17	17	18	0.0047	0.0016
18	18	19	0.3276	0.1083
19	19	20	0.2106	0.0690
20	20	21	0.3416	0.1129
21	21	22	0.0140	0.0046
22	22	23	0.1591	0.0526
23	23	24	0.3463	0.1145
24	24	25	0.7488	0.2475
25	25	26	0.3089	0.1021
26	26	27	0.1732	0.0572
27	3	28	0.0044	0.0108
28	28	29	0.0640	0.1565
29	29	30	0.3978	0.1315
30	30	31	0.0702	0.0232
31	31	32	0.3510	0.1160
32	32	33	0.8390	0.2816
33	33	34	1.7080	0.5646
34	34	35	1.4740	0.4873
35	3	36	0.0044	0.0108
36	36	37	0.0640	0.1565

37	37	38	0.1053	0.1230
38	38	39	0.0304	0.0355
39	39	40	0.0018	0.0021
40	40	41	0.7283	0.8509
41	41	42	0.3100	0.3623
42	42	43	0.0410	0.0478
43	43	44	0.0092	0.0116
44	44	45	0.1089	0.1373
45	45	46	0.0009	0.0012
46	4	47	0.0034	0.0084
47	47	48	0.0851	0.2083
48	48	49	0.2898	0.7091
49	49	50	0.0822	0.2011
50	8	51	0.0928	0.0473
51	51	52	0.3319	0.1114
52	9	53	0.1740	0.0886
53	53	54	0.2030	0.1034
54	54	55	0.2842	0.1447
55	55	56	0.2813	0.1433
56	56	57	1.5900	0.5337
57	57	58	0.7837	0.2630
58	58	59	0.3042	0.1006
59	59	60	0.3861	0.1172
60	60	61	0.5075	0.2585
61	61	62	0.0974	0.0496
62	62	63	0.1450	0.0738
63	63	64	0.7105	0.3619
64	64	65	1.0410	0.5302
65	11	66	0.2012	0.0611
66	66	67	0.0047	0.0014
67	12	68	0.7394	0.2444
68	68	69	0.0047	0.0016

Tie line

69	69	69	69	69
70	70	70	70	70
71	71	71	71	71
72	72	72	72	72
73	73	73	73	73